

Applicable sockets:
SO-1049-8772/8774

Application Notes:
102
007
023

- 115 Vac and 28 Vac, 400 Hz and 50/400 Hz Coil Voltages
- All weld construction

• Contact arrangement **2 PDT**

• Qualified to **MIL-PRF-83536**

PRINCIPLE TECHNICAL CHARACTERISTICS

- **Contacts rated at** 28 Vdc; 115 Vac, 400 Hz, 1Ø and 115/200 Vac, 400 Hz, 3Ø
- **Weight** 0.088 lbs. max
- **Dimensions** 1.01 in x .51 in x 1.12 in
- **Special models available upon request**
- **Hermetically sealed, corrosion resistant metal can**

CONTACT ELECTRICAL CHARACTERISTICS

Contact rating per pole and load type [1]	Load current in Amps				
	@28 Vdc	@115 Vac 400 Hz	@115/200 Vac 400 Hz, 3Ø	@115/200 Vac 60 Hz, 3Ø [6]	@230/400 Vac 400 Hz, 3Ø [8]
Resistive	10	10	10	2.5	5
Inductive [5]	8	8	8	2.5	5
Motor	4	4	4	2	2
Lamp	2	2	-	-	-
Overload	40	60	60	N/A	N/A
Rupture	50	80	80	N/A	N/A

AMERICAS.

Tel: +1 714-736-7599
<http://www.esterline.com/powersystems>

EUROPE.

Tel: +33 3 87 97 31 01
Fax: +33 3 87 97 96 86

ASIA

Tel: +852 2 191 3830
Fax: +852 2 389 5803

COIL CHARACTERISTICS (Vac)

CODE	Vac 400 Hz		Vac 50 through 400 Hz		Vac 400 Hz [6]
	E	F	J	K	T
Nominal operating voltage	28	115	28	115	230
Maximum operating voltage	30	122	30	122	248
Maximum pickup voltage					
- Cold coil at +125° C	22	90	23	95	180
- During high temp test at +125° C	24.4	95.4	24.6	100	185
- During continuous current test at +125° C	25.6	103.5	25.9	105	195
Maximum drop-out voltage	10	30	10	30	60
Coil current max milliAmperes at +25° C	240	40	100	24	22

GENERAL CHARACTERISTICS

Temperature range	-70°C to +125°C
Minimum operating cycles (life) at rated load	100,000
Minimum operating cycles (life) at 25% rated load	400,000
Dielectric strength at sea level	
- All circuits to ground and circuit to circuit	1250 Vrms
- Coil to ground	1000 Vrms
Dielectric strength at altitude 80,000 ft	500 Vrms [2]
Insulation resistance	
- Initial (500 Vdc)	100 M Ω min
- After environmental tests (500 Vdc)	50 M Ω min
Sinusoidal vibration (A, D and J mounting)	0.12 d.a. / 10 to 70 Hz 30G / 70 to 3000 Hz
Sinusoidal vibration (G mounting)	0.12 d.a. / 10 to 57 Hz 20G / 57 to 3000 Hz
Random vibration	
- Applicable specification	MIL-STD-202
- Method	214
- Test condition - A, D and J mounting	1G (0.4G ² /Hz, 50 to 2000 Hz)
- Test condition - G mounting (E in track)	1E (0.2G ² /Hz, 50 to 2000 Hz)
- Duration	15 minutes each plane
Shock (A, D and J mounting)	200G / 6 ms
Shock (G mounting)	100G / 6 ms
Maximum contact opening time under vibration and shock	10 μs
Operate time at nominal voltage@25°C	15 ms max
Release time at nominal voltage@25°C	50 ms max
Contact make bounce at nominal voltage@25°C	1 ms max
Contact release break bounce at nominal voltage@25°C	0.1 ms max
Weight maximum	0.088lb

Unless otherwise noted, the specified temperature range applies to all relay characteristics.

Dimensions in inches
 Tolerances, unless otherwise specified, ± 0.03 in

MOUNTING STYLES

MOUNTING STYLE A

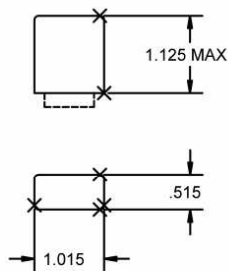

MOUNTING STYLE D

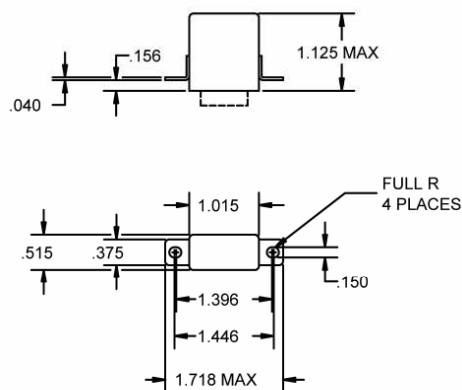

MOUNTING STYLE J

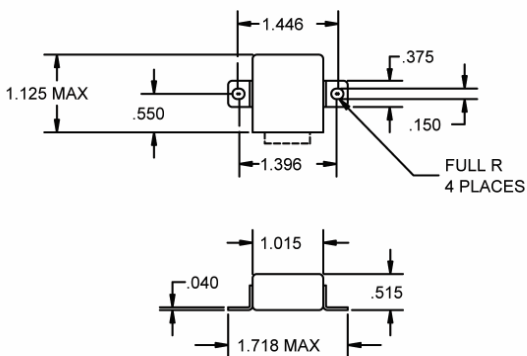

MOUNTING STYLE W

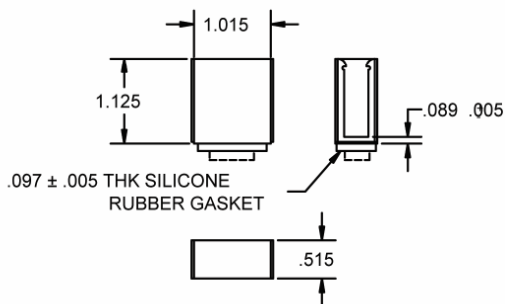

FOR USE WITH TRACK MOUNT SYSTEM. NOTE: TRACK SYSTEM NOT AVAILABLE FROM LEACH.

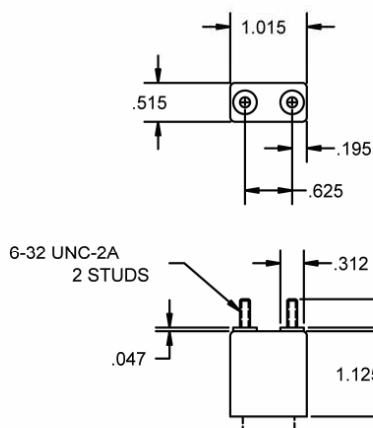
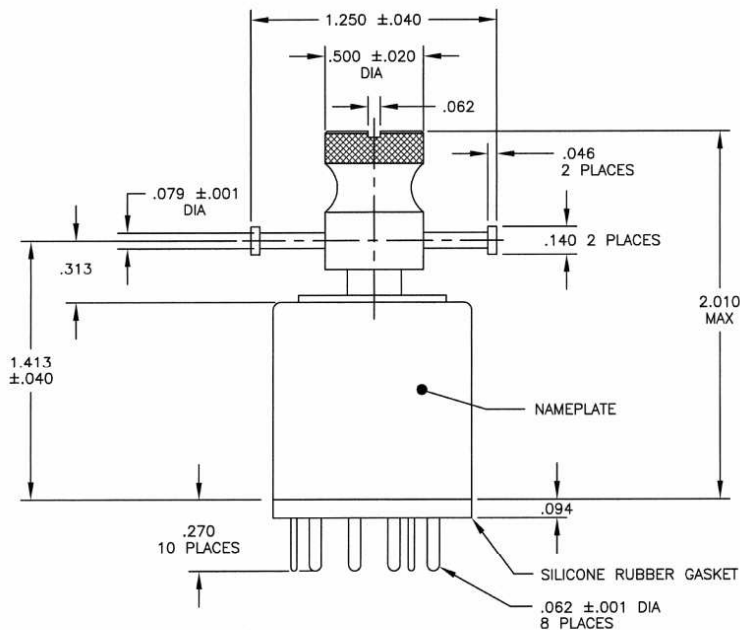

MOUNTING STYLE G

TERMINAL TYPES

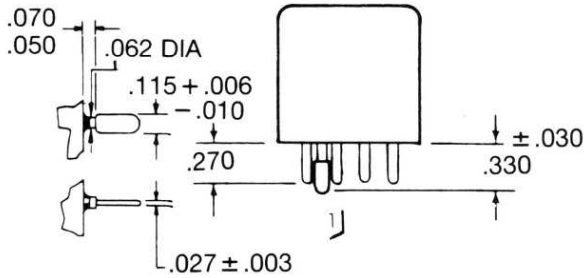

POLARIZING PIN

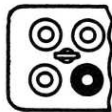
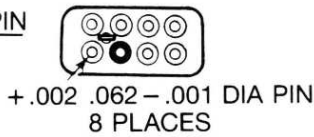

COIL CODE F, K



COIL CODE E, J

TERMINAL TYPE 1

FINISH:
TIN/LEAD PLATE

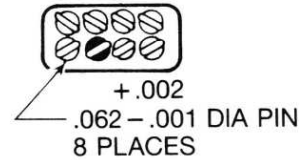
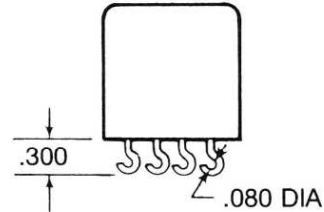

TERMINAL TYPE 2

FINISH:
TIN/LEAD PLATE

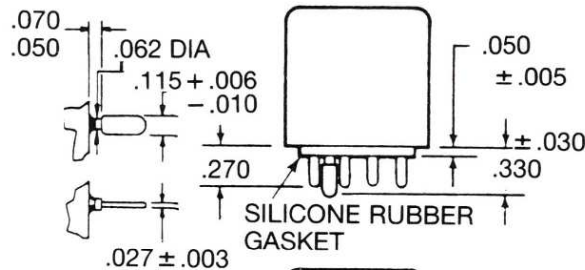

POLARIZING PIN



COIL CODE F, K



COIL CODE E, J

TERMINAL TYPE 4

FINISH: CASE – TIN/LEAD PLATE
 PINS – GOLD PLATE
 POLARIZING PIN – TIN/LEAD PLATE

DIAGRAMS

SCHEMATIC DIAGRAM

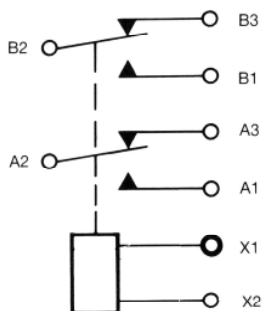

WIRING DIAGRAM

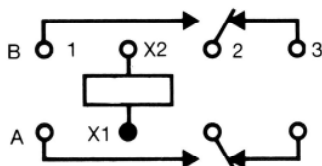

STANDARD TERMINAL LAYOUT

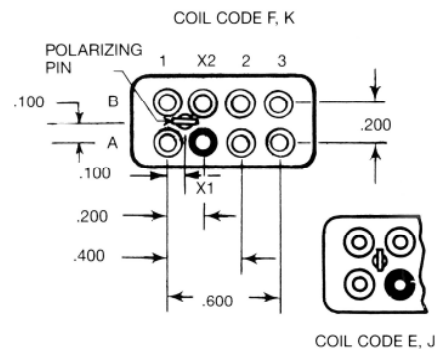

STANDARD TOLERANCE: = $\pm .010$
[1] COIL POLARITY NOT APPLICABLE TO AC VERSIONS.

NUMBERING SYSTEM

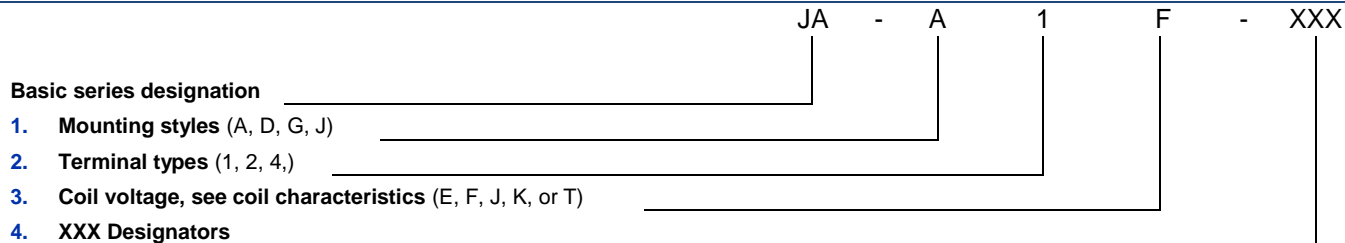

NOTES

- Standard Intermediate current test applicable.
- 500 Vrms with silicone gasket compressed, 350 Vrms all other conditions.
- Applicable military specification: MIL-PRF-83536/11.
- Special models available: Dry circuit, established reliability testing, etc.
- Inductive load life, 20,000 cycles for AC and 10,000 cycles for DC.
- 60 Hz load life, 10,000 cycles.
- Time current relay characteristics per MIL-R-83536
- Temperature range: Non-operating -62° C to +95° C Operating -54° C to +71° C

For any inquiries, please contact your local Esterline Power Systems representative
<http://www.esterline.com/powersystems/Contact/TheAmericas.aspx>