

R19IT3S-MRA2

19" Intel® Core™ i7-1165G7 Marine Panel PC

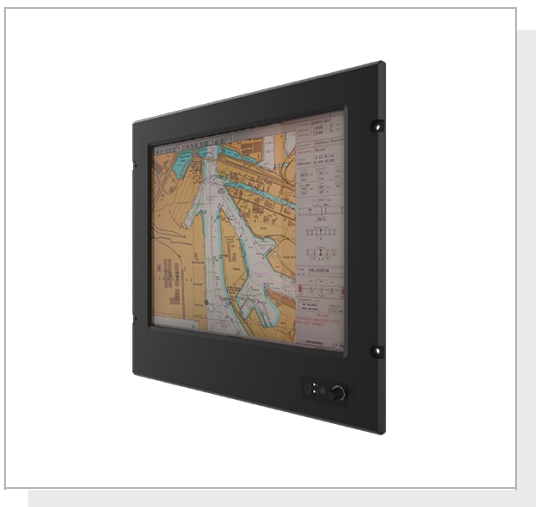

KEY FEATURES

- Intel® Core™ i7-1165G7 processor marine panel PC
- Dimming knob control backlight brightness from nearly 0% to 100%
- 9~36V DC power input acceptable
- Panel (flush) mount IP66 aluminum housing with powder coating design



SPECIFICATIONS

Display	
Resolution	1280x1024
Contrast Ratio	1000:1
View Angles	85,85,80,80
Touch / Glass	Resistive Touch Screen AR Glass (Optional)
Size	19 inches
Panel Brightness	350 nits
Active Area	376.32x301.06 mm
System Specification	
Processor	Intel Core i7-1165G7 2.8GHz (up to 4.7GHz)
Memory	1 x SO-DIMM, DDR4 2400 MHz, 4GB 8GB (Optional) 16GB (Optional) 32GB (Optional)
Storage	1 x M.2 2242 B-key SSD 128GB M.2 2242 B-key SSD up to 512GB (Optional) M.2 2280 M-Key NVME SSD, up to 4TB (Optional)
Ethernet controller	2 x Intel® Ethernet Controller
Operating System	Windows 10 IoT Enterprise (64 bit) (Optional) Windows 11 IoT Enterprise SAC (64 bit) (Optional) Linux Ubuntu 22.04 (Optional)
Environment	
Operating Humidity	5% to 95%
Operating Temperature	-15~55°C
Shock	15G, 11ms duration
Vibration	0.7g@DNVGL CG-0339 (Class A)
IP rating	IP66 (Front Side)
Certification	
Certification	CE, FCC
IO Ports	
USB Port	2 x USB 3.0
Serial Port	1 x RS232, 4 x RS232 or 4 x Isolation RS422/485 (Optional)
Video	1 x VGA 1 x HDMI (Optional)
LAN	2 x RJ45-10/100/1000 Mbps
Mechanical	
Dimension	425 x 303 x 77.5 mm
Mounting	VESA Mount/ Panel Mount
Enclosure	Metal Housing with Aluminum Bezel
Cooling System	Fanless Design

Cut out	429 x 396 mm		
Accessory	Driver CD & User Manual 4 x M6 Black Screw Bolt with M6 Nut 1 x AC Adapter 12V/ 84W 1 x Power Cord		
Power			
Power Rating	24V DC-in with Isolation (Approval by Certificate) 9~36V DC Input Acceptable	Consumption	65W (Typical)
Control			
Button	1 x Power Button 1 x Reset Button 1 x The Dimming Knob		

DIMENSIONS UNIT:MM

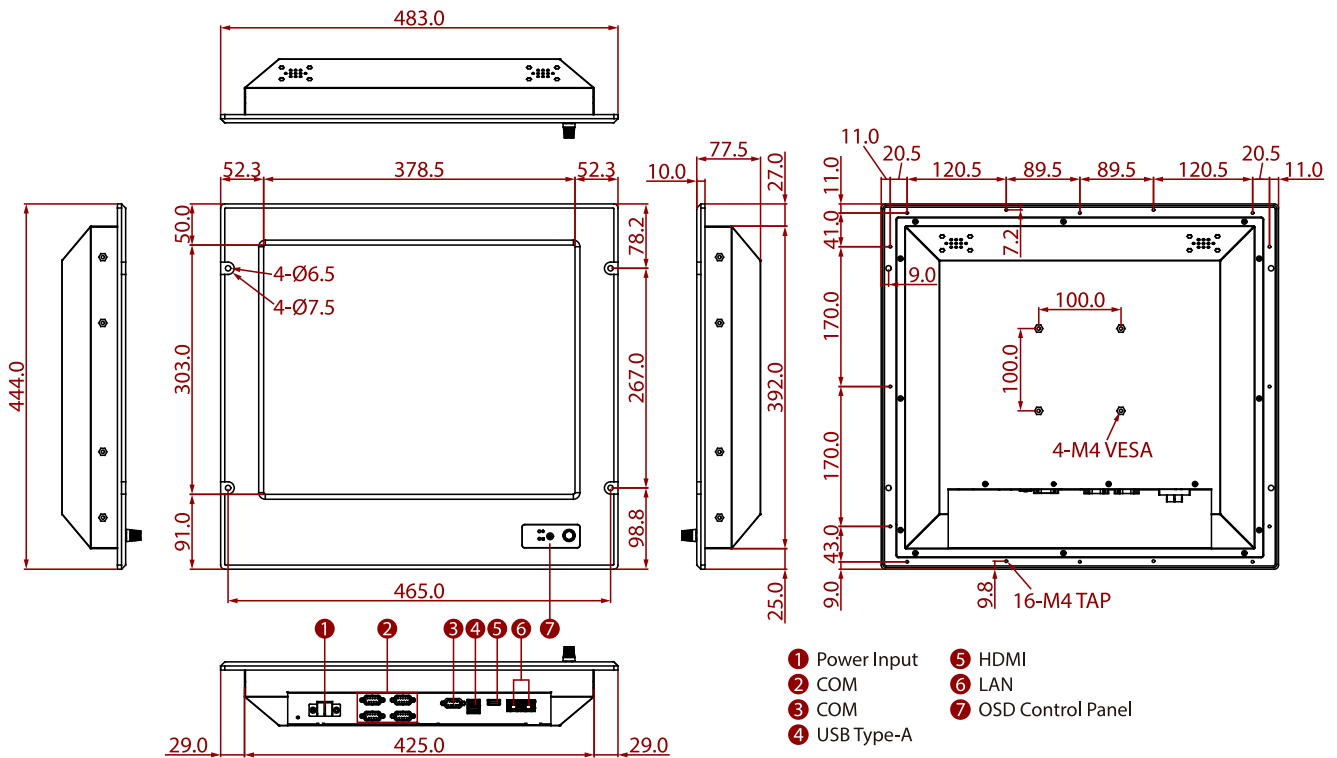

NOTE

1. This is a simplified drawing and some components are not marked in detail.
2. Please contact our sales representative if you need further product information.
3. All specifications are subject to change without prior notice.
4. The product shown in this datasheet is a standard model. For diagrams that contain customized or optional I/O, please contact the Winmate Sales Team for more information.